

## Features

- ID1 full size card acceptance
- Card detection sealed switch
- Compatible with pick and place and lead free soldering

## Typical Applications

- Transaction
- POS
- Identification

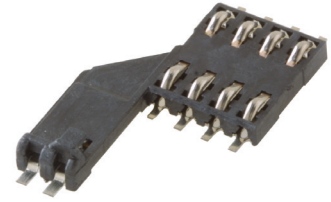

## Mechanical

Number of contacts	6 or 8
Mechanical life	50,000 cycles
Card insertion force	10N max
Card extraction force	1N min / 10N max
Contact force	0,4N to 0,7N
Card detection switch	0,8 N max for actuation (end travel switch actuation force actuates when card is 0,9mm from card stop) 1,8 N max for complete depression
Vibration Frequency	10 to 500 Hz. Acceleration 50m/s <sup>2</sup> Duration 6 hours - amplitude 0,35mm
Shock	Peak value 500 m/s <sup>2</sup> – Duration 11 ms 3 shocks in each direction of each axis
Max elect. discontinuity	1µs

## Packaging

See table below

## Soldering Process

Compatible with lead free SMT reflow soldering process

## Contact Electrical Data

Insulation resistance	1000 MΩ min
Contact resistance max	100 mΩ max
Switching current	10 µA min / 1 A max
Dielectric strength	750 Vrms min

## Switch Electrical Data

Card detection switch	Normally open
Rc card detection switch	100 mΩ max
Dielectric strength	250 Vrms min
Switch current rating	1 mA min / 10 mA max
Maximum switch power	0.2 VA

## Environmental Data

Operating temperature	-40°C to +85°C
Salt mist	IEC 512 test number 11f (96 hours)
Damp heat	IEC 512 test number 11c (10 days)
Card detection switch	Sealed against dust
RoHS compliant	

Designation	Housing Type	# of Contacts	Contact Force	Total Height (mm)	Total Dim. (mm)	Packaging
CCM04-5427LFT	standard	8	0,4N to 0,7N	2,65	18,75 X 25	reels of 1,000 pcs
CCM04-5436LFT	standard	8	0,4N to 0,7N	0,90	18,75 X 26,9	reels of 1,000 pcs
CCM04-5454LFT	standard	8	0,4N to 0,7N	0,90	18,75 X 26,9	reels of 1,000 pcs
CCM04-5455LFT	standard	8	0,4N to 0,7N	0,90	18,75 X 26,9	reels of 1,000 pcs

# CCM04 MK4 Series

CCM04-5427 LFT

Full Size

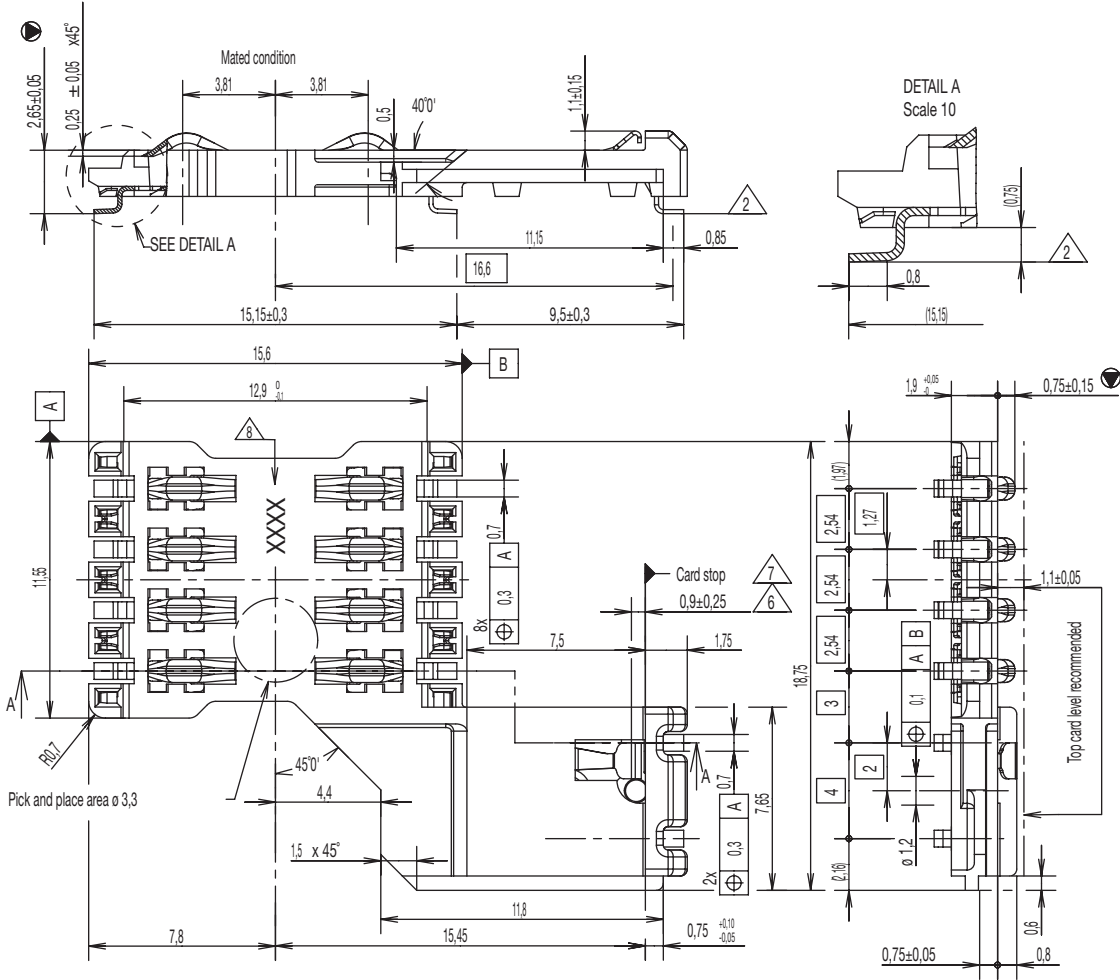

RECOMMENDED PC BOARD LAYOUT  
(Component side)

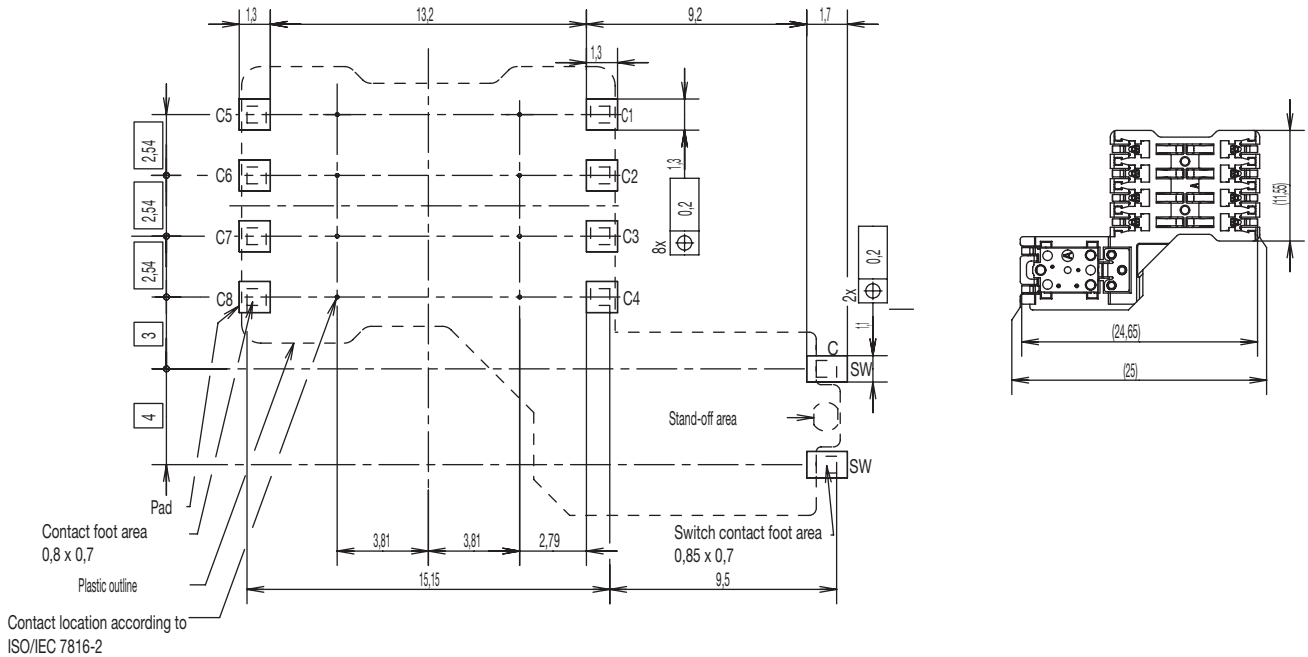

11 Nov 19

Dimensions are shown in mm  
Specifications and dimensions subject to change

www.ckwitches.com

CCM04-5436 LFT

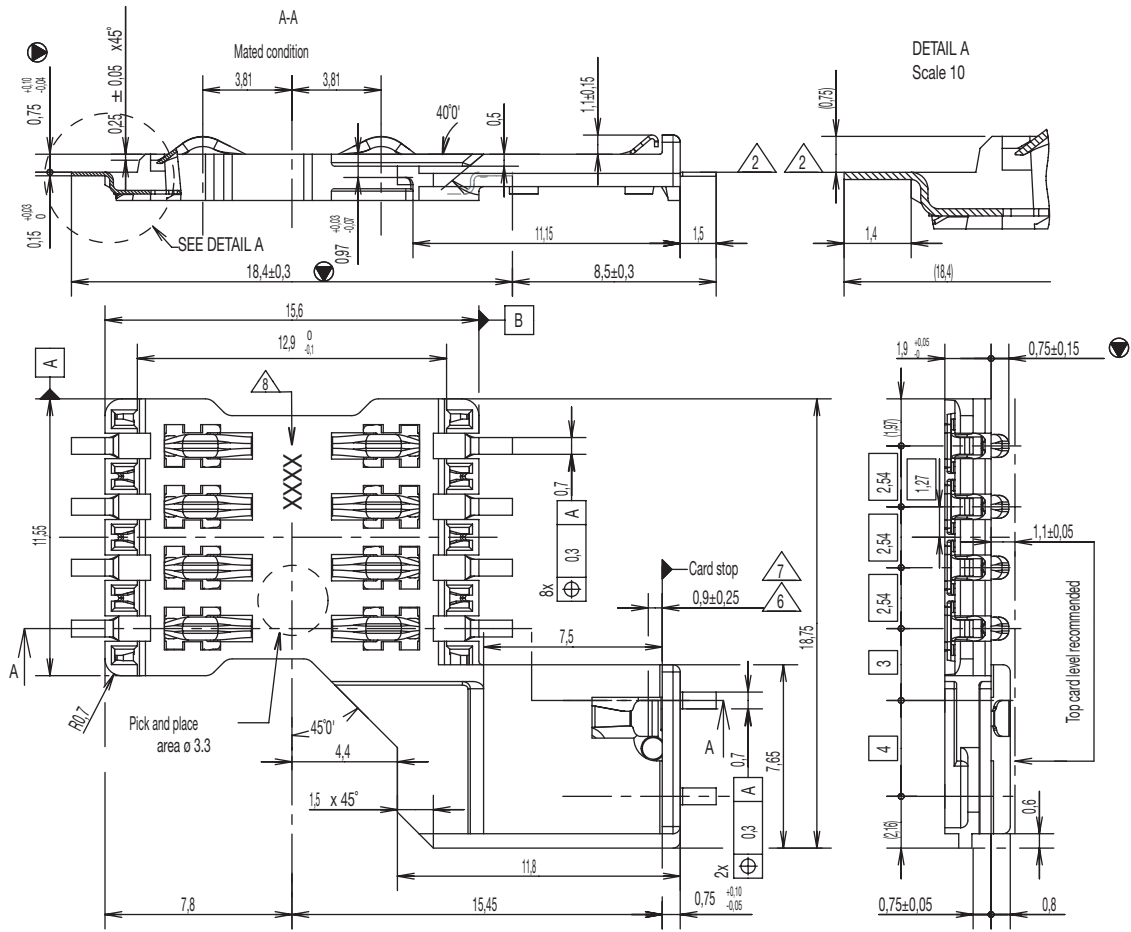

RECOMMENDED PC BOARD LAYOUT  
(Component side)

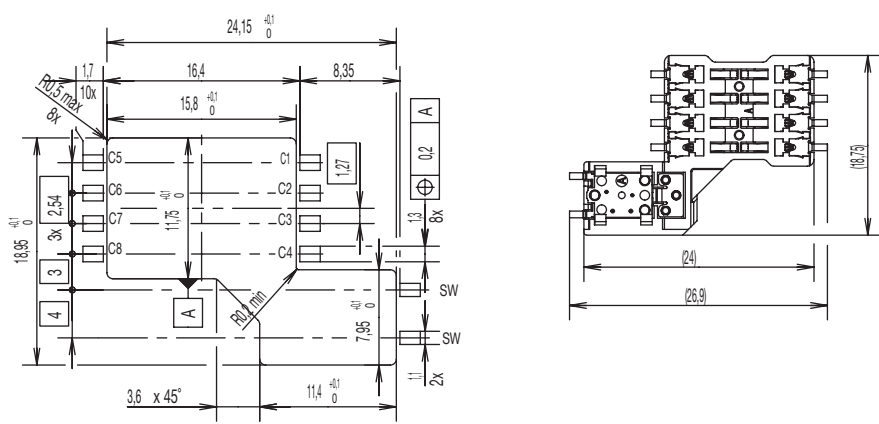

11 Nov 19



Dimensions are shown in mm  
Specifications and dimensions subject to change

[www.ckwitches.com](http://www.ckwitches.com)

Full Size

# CCM04 MK4 Series

## CCM04-5454 LFT

Full Size

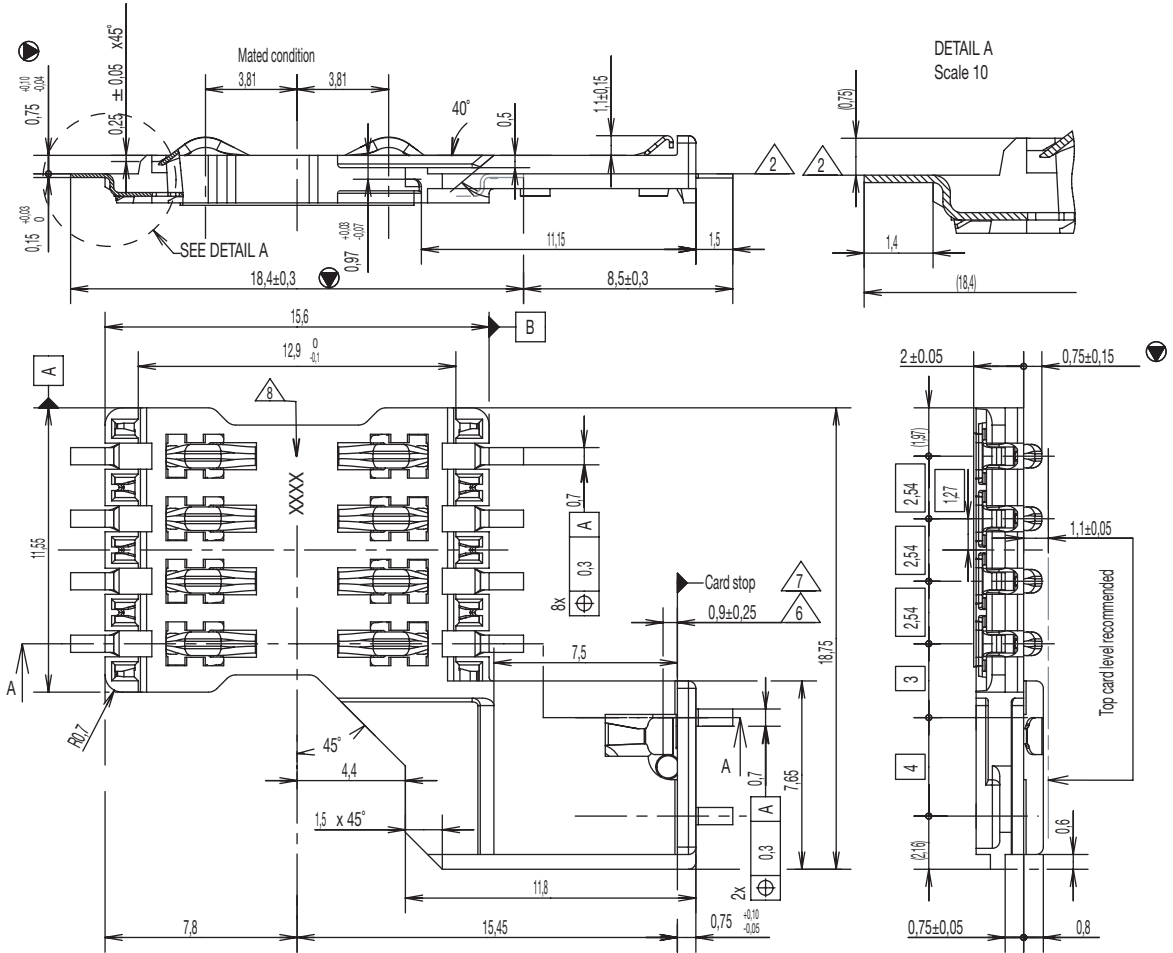

RECOMMENDED PC BOARD LAYOUT  
(Component side)  
Scale 2,5

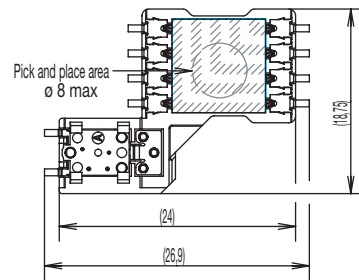
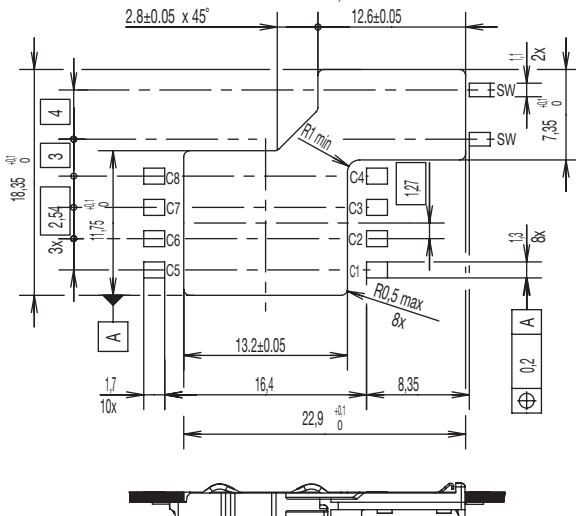

11 Nov 19



Dimensions are shown in mm  
Specifications and dimensions subject to change

www.ckwitches.com

# CCM04 MK4 Series

CCM04-5455 LFT

Full Size

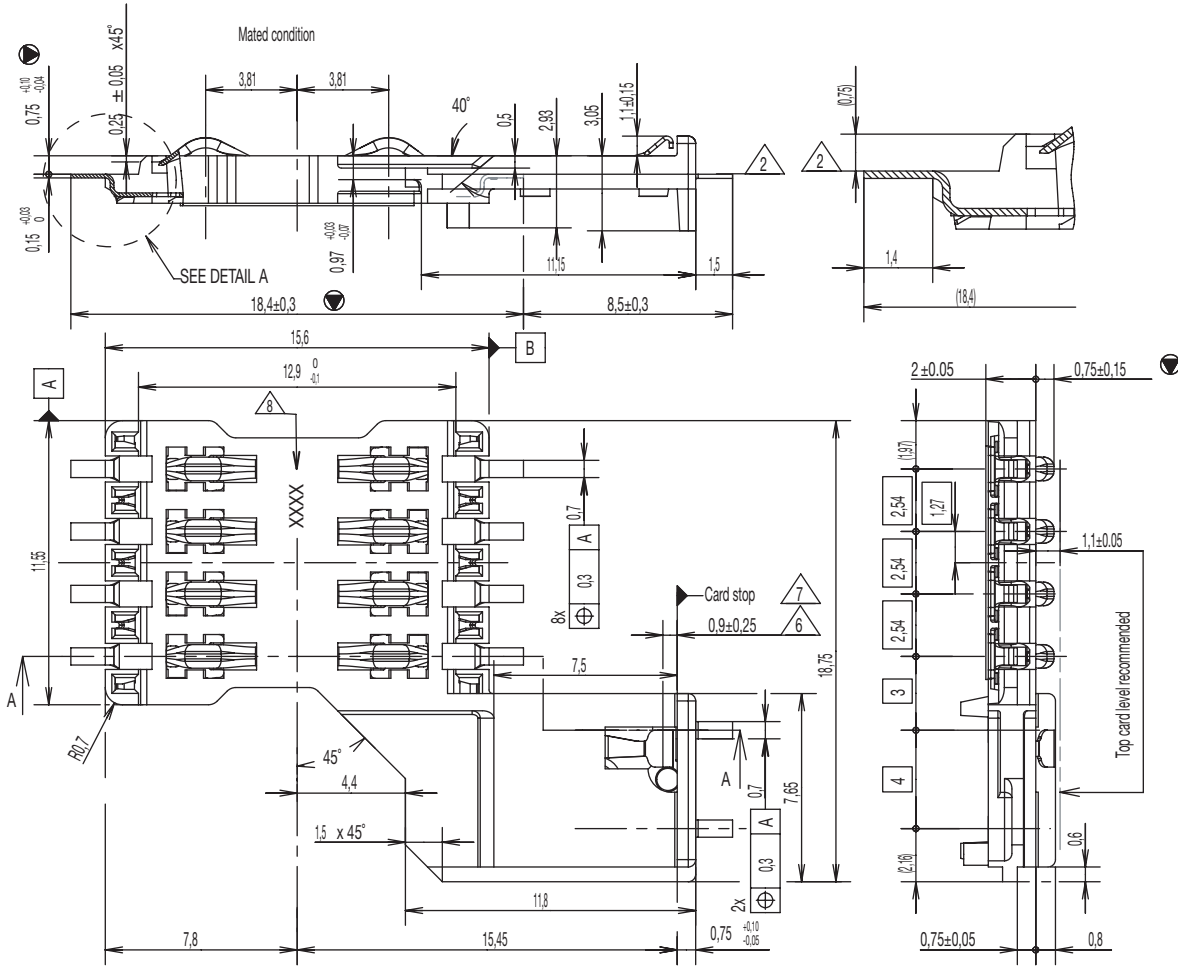

RECOMMENDED PC BOARD LAYOUT  
(Component side)  
Scale 2,5

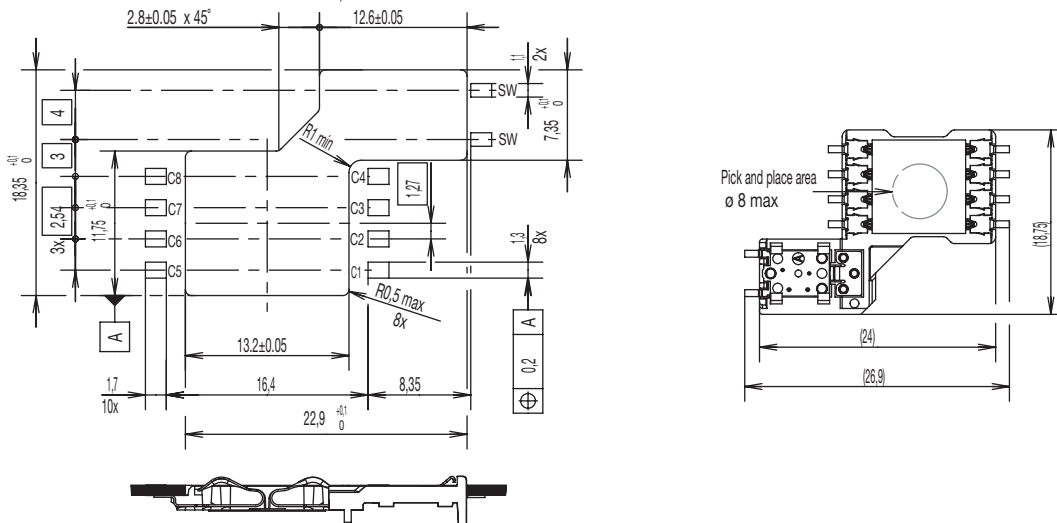

11 Nov 19



Dimensions are shown in mm  
Specifications and dimensions subject to change

www.ckwitches.com